

C17038P SERIES



SIZE :

172*152*38mm

CONSTRUCTION :

- Die-cast aluminum housing
- Glass fiber reinforced plastic:
Impeller are UL 94V-0 rating
- Impedance protected
- Leader wire or terminal is available

OPERATING TEMPERATURE :

Ball bearing - 30°C to +75°C

*Minimum ambient temperature -15°C , admissible for a short time at -30°C ; without reaching dew point.

Sleeve bearing - 10°C to +60°C

WEIGHT :

800 grams

Specifications

Specifications are subject to change without notice

MODEL NO.	BEARING	RATED VOLTAGE	FREQUENCY	MAX. RATED CURRENT	MAX. INPUT POWER	SPEED	MAX. AIR FLOW	MAX. AIR PRESSURE	NOISE
		VAC	Hz	mA	W	R.P.M.	CFM	IN H ₂ O	dB-A
CB17038 -115HP	Ball	115	50/60	400/350	14/12	2550/2700	150/170	0.39/0.52	48/51
CS17038 -115HP	Sleeve								
CB17038 -230HP	Ball	230	50/60	210/170	14/12	2550/2700	150/170	0.39/0.52	48/51
CS17038 -230HP	Sleeve								

Dimensions (mm)

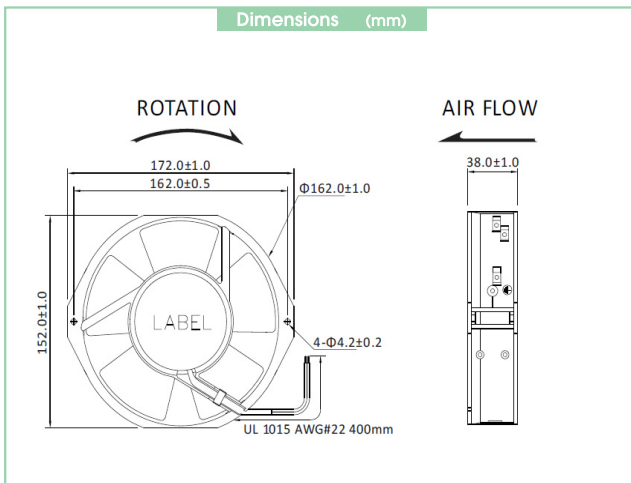

Performance Curve

